



Tricom Asia Limited

A VN-HK SUBMARINE CABLE PROJECT

Submarine Network Worlds

Singapore

20-23 September 2005



About Tricom Asia Limited

- Hong Kong registered company
- Swedish Investors and Management
- Prospecting a new submarine cable from Hong Kong to Vietnam since 2001
- MoU signed in London 2003
- Currently three Tricom Asia offices:

Europe

Grev Turegatan 14
Box 5339
102 47 Stockholm
Sweden

Vietnam

Hanoi Horizon Office Suite
Room A3, 3rd floor
40 Cat Linh Street
Hanoi, Vietnam

Hong Kong

Room 1405, 14F China
Merchant Bldg No. 303
Des Voeux Rd,
Central, Hong Kong



Overview of a VN-HK Cable System

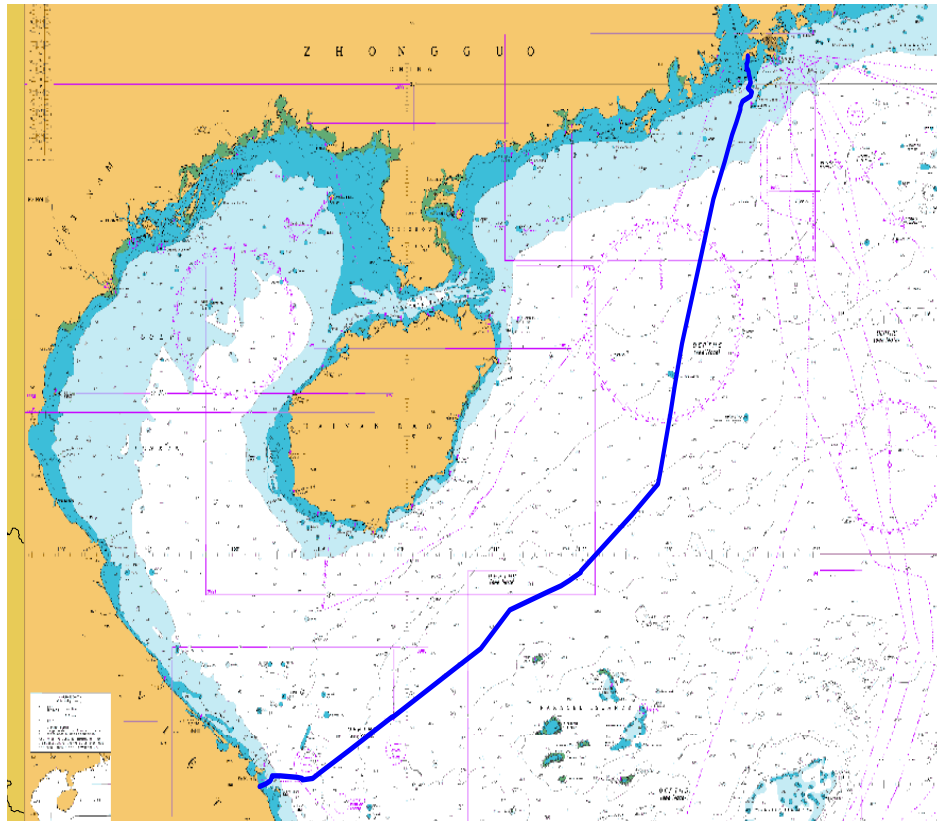

Anticipations

Da Nang – Hong Kong
Approximately 1050 km
4 Fibre Pair solution
Existing Cable Landing
Stations and Backhails
City PoP to City PoP
service delivery
Seamless extensions
via international
interconnects



Overview of Project and System responsibilities

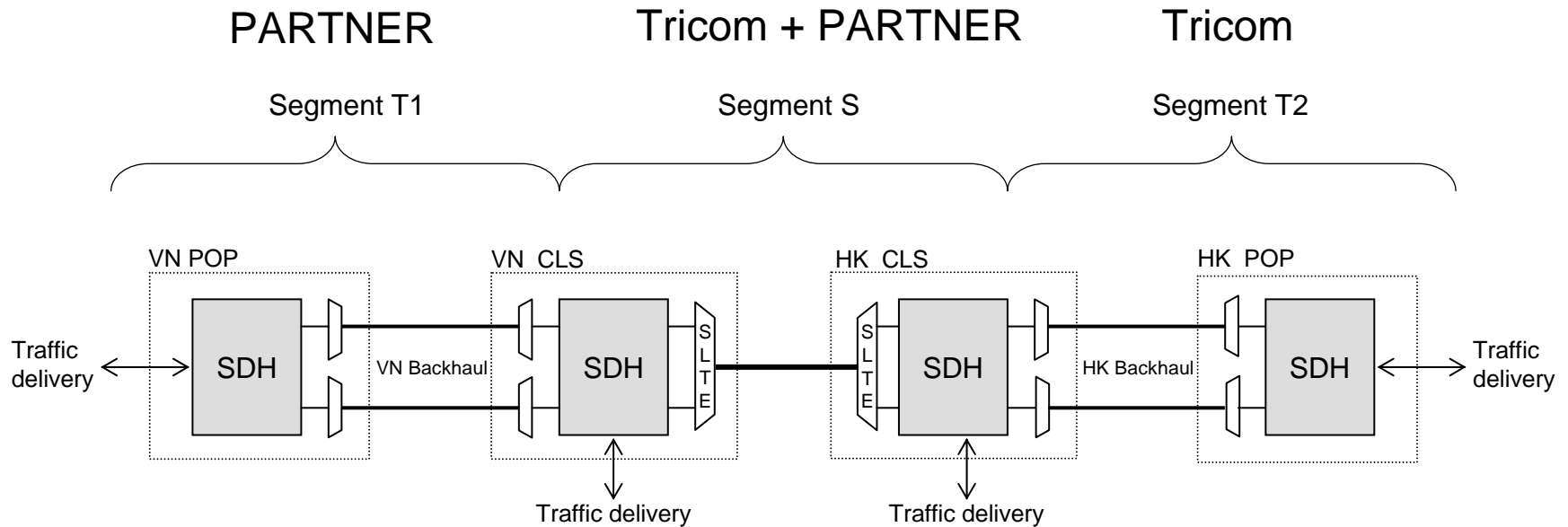

Responsibility includes Procurement, Ownership, Operation and Maintenance

CLS	Cable Landing Station
POP	Point Of Presence
SDH	Synchronous Digital Hierarchy
SLTE	Submarine Line Terminal Equipment



Overview of Segment T2

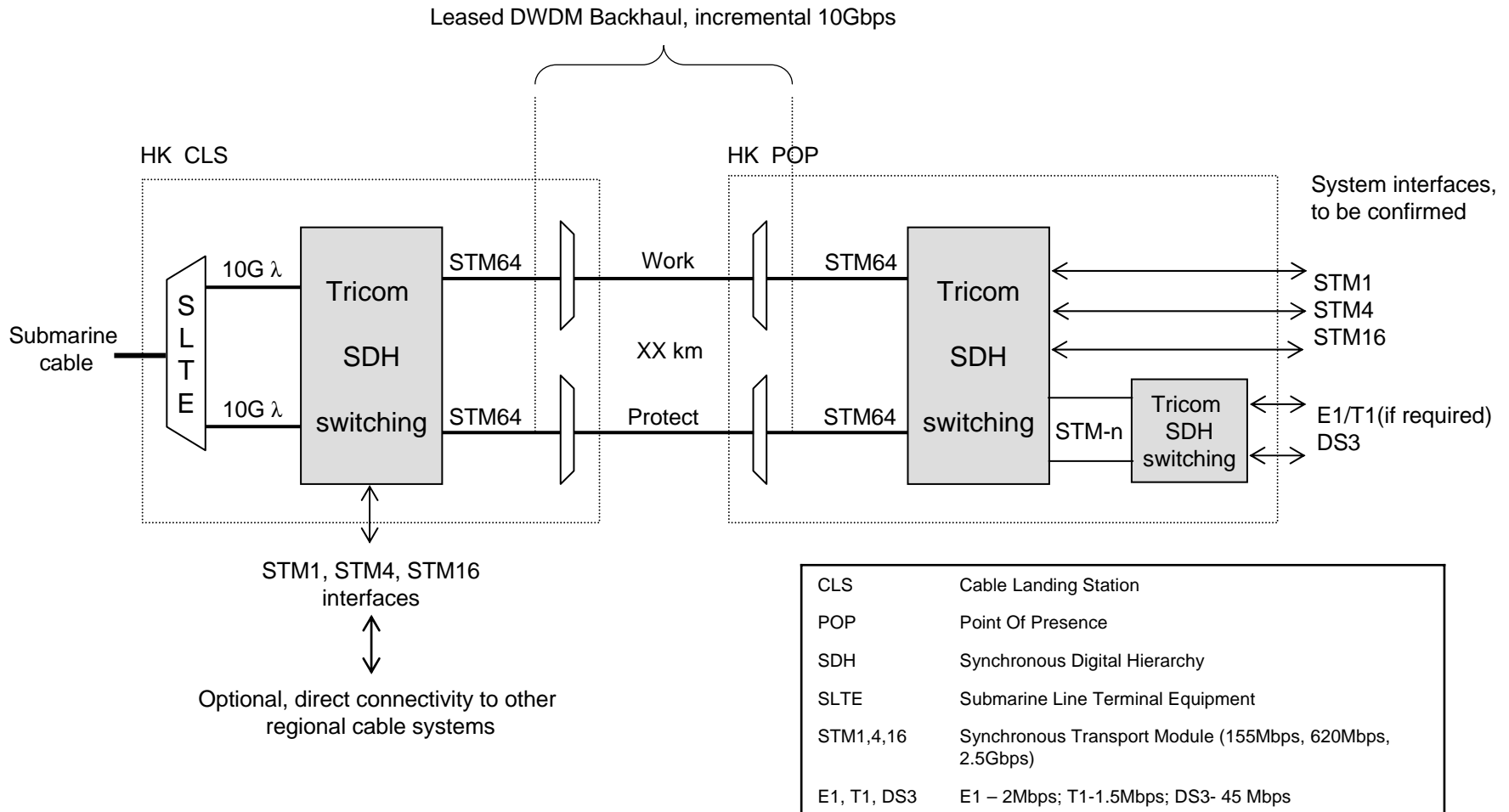



Current status

- Tricom Tender process for Segment T2
 - Cable Landing Station
 - City PoP
 - Backhaul
 - O&M Services
- International Tender process for Segment S
- Estimated Project schedule
 - Segment T2 tender complete: 31/10/2005
 - Segment S tender complete: 31/03/2006
 - Ready For Service (RFS): 01/01/2007



The Vietnamese Market in general

- Vietnam is one of the fastest growing telecommunication markets in the world
- Large and growing population of 82.5M people and exciting demography
- Telecommunication development is rapid starting from a low penetration level
- Vietnam is dedicating substantial investments to improve the domestic telecommunication and IT infrastructure
- Currently regulated prices for international telecommunications services
- International connectivity is limited and getting highly utilised
- US-Vietnam bilateral trade agreement and imminent WTO entry
- Potential production outsourcing alternative in the region



Telecommunications in Vietnam

- Vietnam Post and Telecommunications (VNPT) is the market leader
- Gradual deregulation is occurring in the market
- Competition introduced in all service areas fixed, mobile, internet access, etc.
- Typically foreign investments in telecommunication infrastructure have been through Business Corporation Contracts (BCC)



Telecommunications Overview (Tricom estimate)

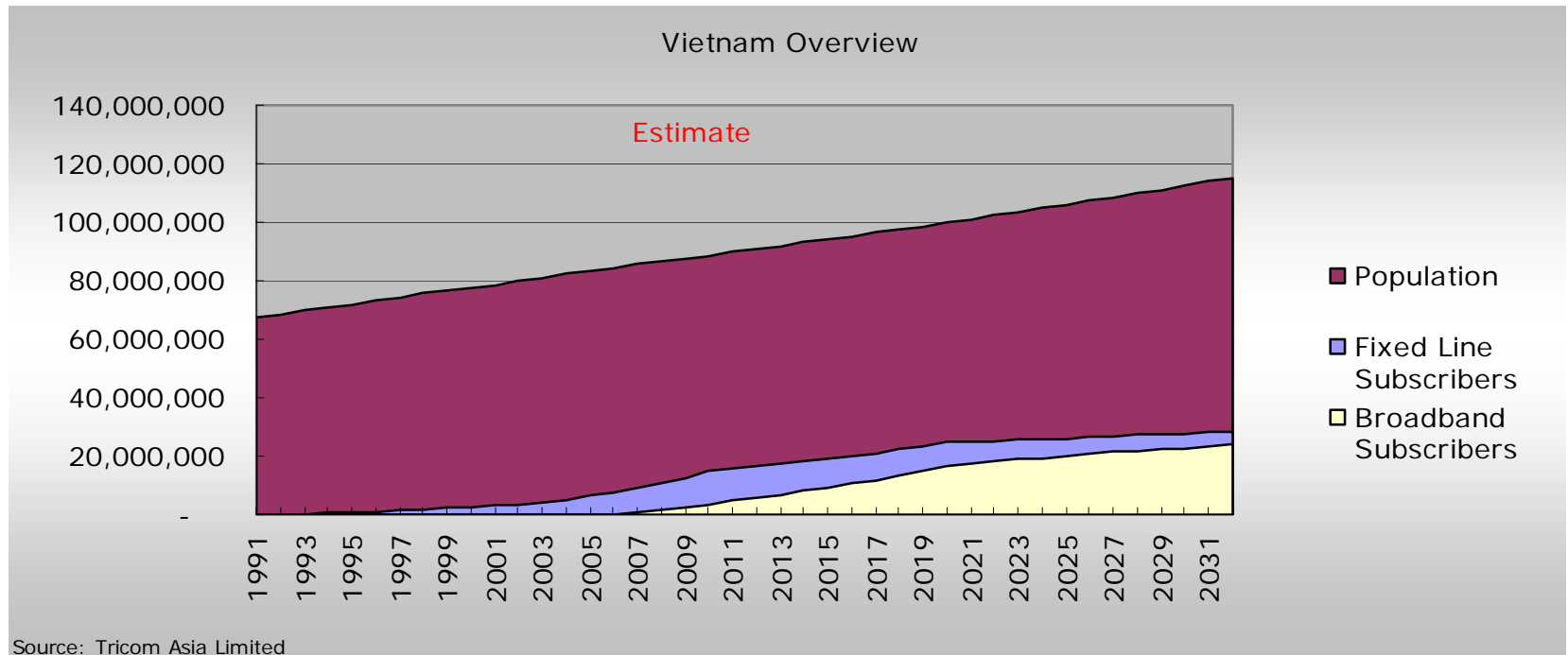

- Subscriber statistics today (actual, of population):
 - Fixed subscribers: 7.8%
 - Mobile subscribers: 6.3%
 - Internet subscribers: 3.3%



Fixed Telephony (Tricom estimate)

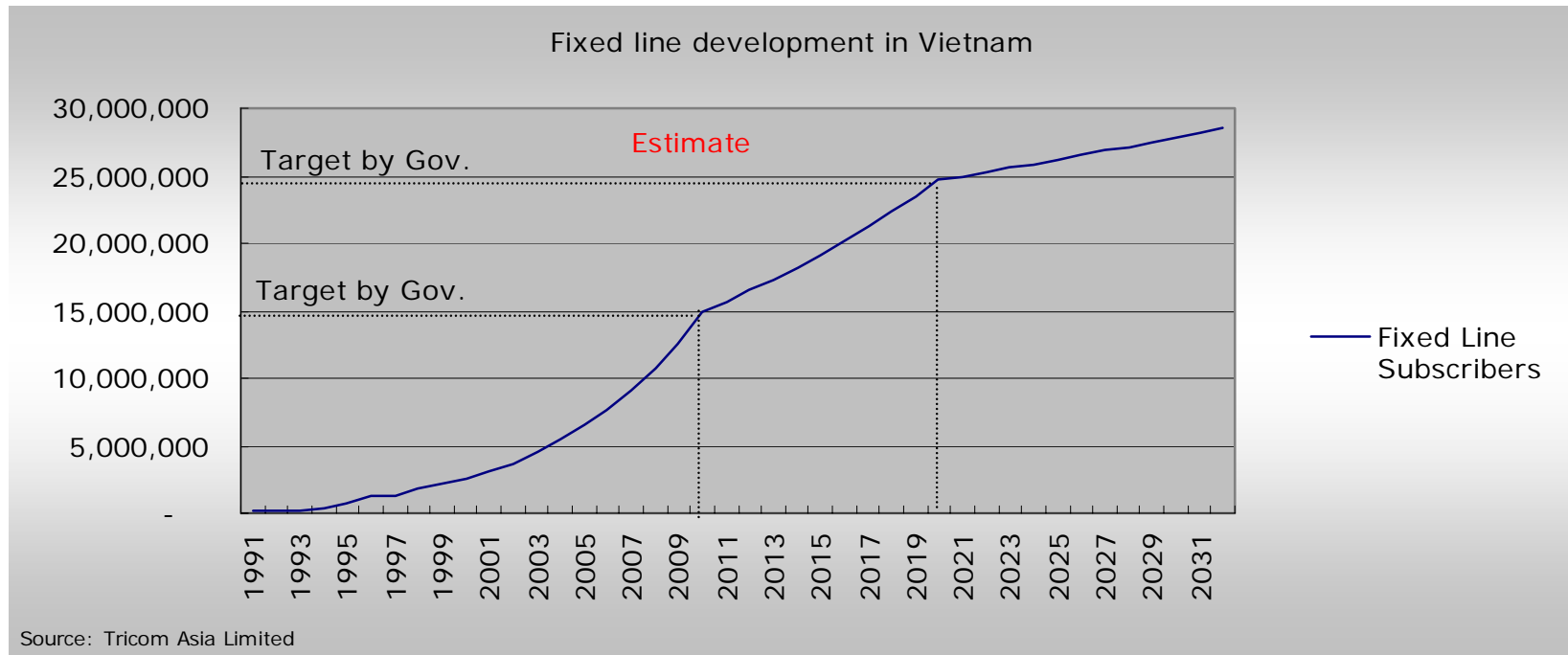

- Vietnam government has set growth targets in policies
- With existing plans Tricom Asia estimates the numbers of fixed lines to reach a subscriber penetration of approximately 17% by 2010 and 25% by 2020.
- Development directly enables broadband rollout



Internet Access (Tricom estimate)

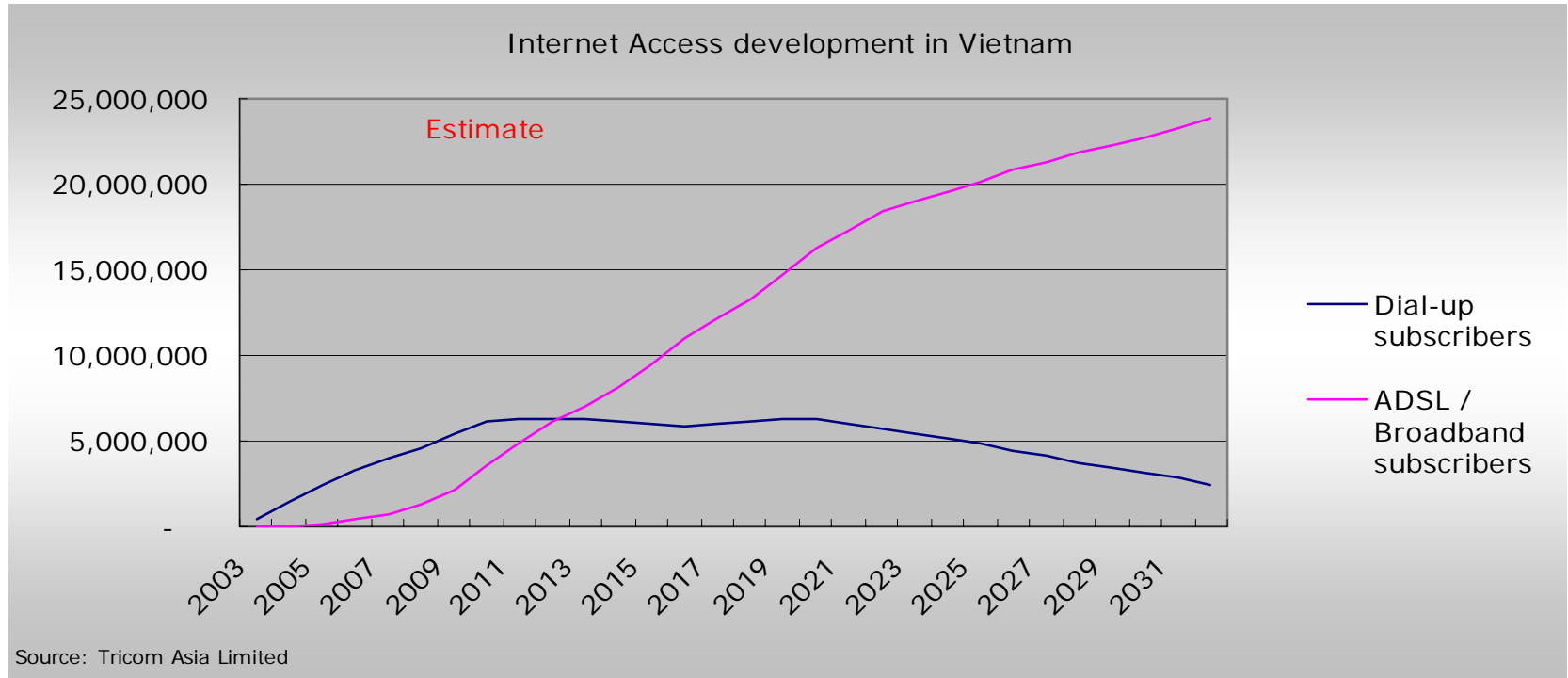

- Likely to become the biggest driver of international bandwidth in Vietnam
- Tricom predicts 50/50 ratio of broadband and dial-up subscribers by 2012



Capacity today (Tricom estimate)

- SMW3 submarine cable system
 - TVH submarine cable system
 - CSC terrestrial cable system from mainland China to South East Asia
 - Satellite systems
- Tricom estimates that utilisation of available international capacity is around 70% today and close to 100% by end of 2006.

Cable System	Estimated Max capacity Vietnam (Gbps)	Estimated utilisation 2005	Estimated utilisation 2006
SMW3	3.9	High	Full
TVH	0.8	Full	Full
CSC	2.5	Medium	Full
Satellite	0.3	High	Full
TOTAL	7.5 Gbps	5.1 Gbps	7.5 Gbps



Expected growth int'l bandwidth (Tricom estimate)

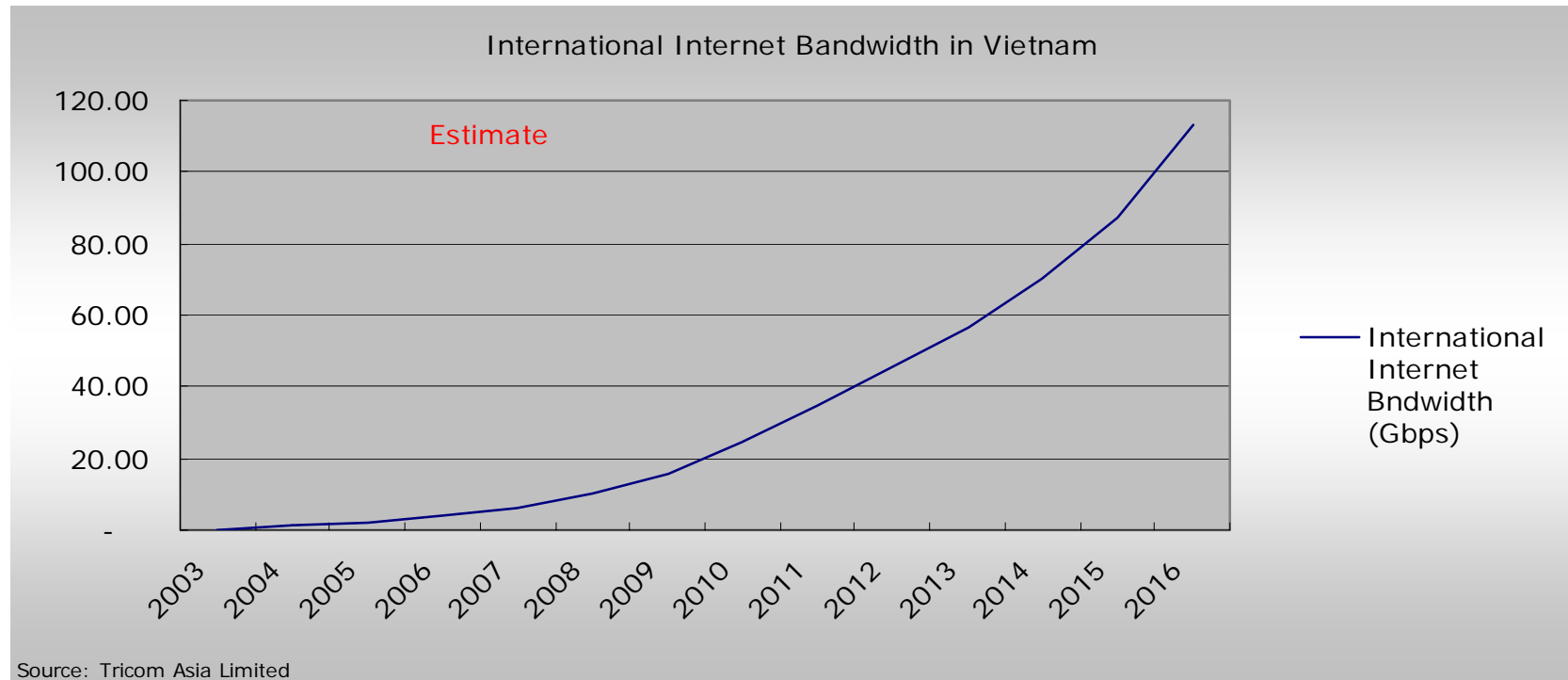

- The VN-HK Cable System will provide international connectivity to and from Vietnam during the next 25 years.



Thank You

For further questions about Tricom Asia please contact:

Mr. Peter Landgren – CEO

Email: p.landgren@tricomasia.com

Mobile: +46 (0) 708 753 939

Mr. Magnus Bjellefors – Chairman of the Board and CFO

Email: m.bjellefors@tricomasia.com

Mobile: +46 (0)768 66 50 12

Mr. Anders Gustafsson – COO

Email: a.gustafsson@tricomasia.com

Mobile: +852 (0) 9025 1853